

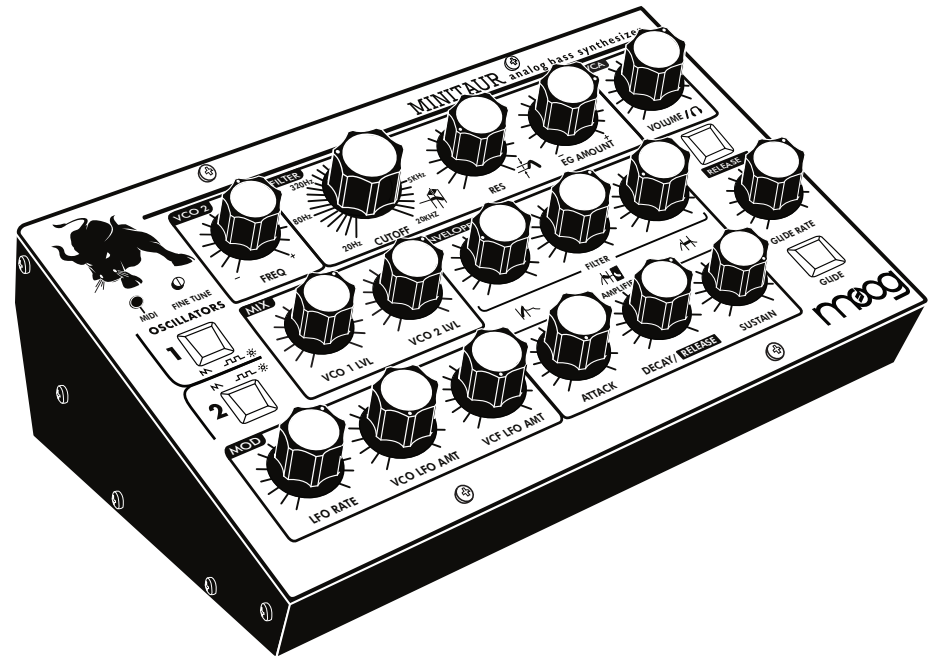

MINITAU

USER'S MANUAL



MINITAU

Congratulations on your new Minitaur Analog Bass Synthesizer, a powerful, compact Moog synthesizer with a classic one knob per function design. At only 8.5" x 5.25" and less than 3lbs, the Minitaur puts legendary analog Moog bass into a package designed to fit seamlessly into all of your performance and production environments.

The Minitaur will bring you many happy years of creative and sonic enjoyment. We are sure you are anxious to start playing, so refer to the "Getting Started" guide or look over the Setup and Connections section to get going. At some point, we encourage you to spend some time with this manual to discover all that the Minitaur has to offer. Don't forget - Experimentation and learning will reward you with a lifetime of rich synthesizer experiences.

IMPORTANT SAFETY INSTRUCTIONS

PLEASE READ BEFORE USING THIS PRODUCT

When using the Minitaur, these basic precautions should always be followed.

1. Read all the instructions before using this product.
2. Do not use the Minitaur near water.
3. This product, in combination with an amplifier and headphones or speakers, may be capable of producing sound levels that could cause permanent hearing loss. Do not operate for a long period of time at a high volume level or at a level that is uncomfortable. If you experience any hearing loss or ringing in your ears, you should consult an audiologist.
4. Keep the Minitaur away from heat sources such as radiators, heat registers, and other products that produce heat.
5. The product should be connected to a power supply only of the type described in the operating instructions.
6. The power supply should be unplugged from the outlet when left unused for long periods of time.
7. Care should be taken so that liquids are not spilled into the front panel.
8. The Minitaur should be serviced by qualified personnel when:
 - a. Objects have fallen, or liquid has been spilled onto the product.
 - b. The product has been exposed to rain.
 - c. The product does not appear to operate normally or exhibits a marked change in performance.
 - d. The product has been dropped or the enclosure damaged.



DANGER -- INSTRUCTIONS PERTAINING TO RISK OF FIRE, ELECTRIC SHOCK, OR INJURY TO PERSONS: Do not open the chassis. There are no user serviceable parts inside. Refer all servicing to qualified personnel only.

CONTENTS

THE BASICS

Unpacking & Inspection.....	4
Setup and Connections.....	4
Overviews and Features.....	6
Signal Flow.....	8
Basic Operation.....	9

THE COMPONENTS

Oscillators.....	9
Glide.....	11
Mix.....	11
Filter.....	12
Envelopes.....	14
Release.....	15
Modulation.....	16
Volume.....	17
Input/Output Panel.....	18

MIDI OPERATIONS

MIDI CC Table.....	22
--------------------	----

APPENDICES

A. MIDI Implementation Chart.....	25
B. Service & Support Information.....	26
C. Caring for Minitaur.....	27
D. Using the CP-251 with Minitaur.....	27
E. Specifications.....	29

UNPACKING AND INSPECTION

CHECK THE CONTENTS IN THE SHIPPING CARTON

The Minitaur is shipped with the following items:

1. The Minitaur Analog Bass Synthesizer
2. A 12VDC Power Adaptor
3. A “Getting Started” guide
4. Registration Card
5. Earplugs

WHAT YOU WILL NEED

1. A MIDI keyboard or MIDI controller
2. A MIDI cable
3. A USB cable to connect the Minitaur to a host computer (for USB MIDI)
4. A 1/4” instrument cable and amplifier, or a pair of headphones with an 1/8” plug

SETUP AND CONNECTIONS

NOTE: We encourage you to read the entire manual at some point to learn more about the instrument and gain a better understanding of what you can do with the Minitaur.

SET UP

Use care when unpacking your Minitaur, and be sure to save the carton and all packing material in case you need to ship it for any reason.

CONNECT TO POWER & MIDI

Connect the supplied Power Adaptor to the Minitaur’s 12VDC power jack on the back of the unit. The Minitaur’s universal power supply will operate with a power source from 100 to 240 Volts AC, 50/60Hz. Using a 5 Pin MIDI cable, make the connection between MIDI OUT of your MIDI controller and the MIDI IN on the Minitaur. The Minitaur is set to receive messages on MIDI Channel 1, so make sure your controller is set to transmit on MIDI Channel 1. If you are using USB MIDI, connect the USB cable from the Minitaur to a USB port on your computer. The Minitaur’s USB drivers are automatically installed, and it will appear as ‘Moog Minitaur’ (Mac OSX or Win 7) or ‘USB Audio Device’ (Win XP) in the MIDI Device selection options of your computer’s MIDI software.

POWER UP

Apply power to the Minitaur and to your MIDI controller.

CONNECT TO AMPLIFIER

Set the Minitaur's volume control to minimum *before* connecting to an amplifier, mixer, or headphones. Set the amplifier volume to a comfortable listening level, and then *slowly* bring up the volume on the Minitaur as you play a few notes. *NOTE: Use caution when adjusting initial volume levels, especially if connected to a subwoofer.*

START PLAYING

Since the Minitaur is a Bass Synthesizer; it operates exclusively in the lower note range (MIDI notes 0 - 72). This means that the Minitaur will respond to your playing from 'C4' (an octave above middle 'C') downward. Play some notes, tweak some knobs and have some fun!

DOWNLOAD THE MINITAU EDITOR PROGRAM

Register your Minitaur online at www.moogmusic.com/register to download the free Minitaur Editor Program. This allows you to load and save patches and access all of the Minitaur's under the hood features. Registering your Minitaur also initiates your warranty, ensures you receive the latest software updates, and gets you a nifty sticker!

NOTE: A warm up period of about 15 minutes is recommended for the Minitaur to reach concert pitch. The warm up period may be a little longer if the Minitaur has been stored outside the recommended operating temperature range.

The recommended operating temperature of the Minitaur is between 50 and 100 degrees Fahrenheit. It is safe to operate the synthesizer outside of this range, but the Minitaur's voltage controlled oscillators may not remain in tune. It is also recommended that the Minitaur not be exposed to direct sunlight while operating.

OVERVIEW AND FEATURES

The Minitaur is a monophonic Analog Bass Synthesizer with a 100% analog audio path. It is based on the legendary Taurus I and Taurus 3 Synthesizers. The Minitaur features 2 ultra-stable voltage controlled oscillators, a genuine Moog low pass filter, 2 envelope generators and a modulation circuit. The Minitaur has a classic one knob per function design in a rugged performance package that is small enough to take with you anywhere.

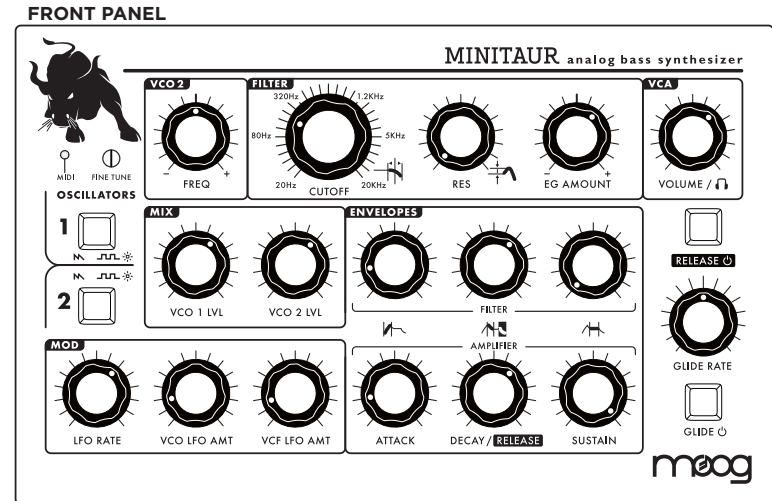

OSCILLATORS

Two Voltage Controlled Oscillators with selectable Sawtooth (original Taurus) and Square waveshapes.

MIX

Mixer for adjusting VCO levels independently.

FILTER

Classic Moog 24dB/Octave Low Pass Filter with adjustable Resonance.

ENVELOPES

Twin Minimoog style ADSR Envelope Generators for modulating the Filter (VCF) and Amplifier (VCA). The Envelope Decay and Release segments are controlled by the DECAY knob, while the Release segment is enabled or disabled via the RELEASE switch.

MOD

MIDI-syncable Low Frequency Oscillator (LFO) with Rate control and individual VCO and VCF AMOUNT controls.

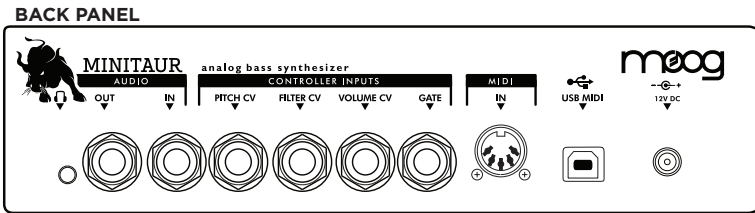

HEADPHONE OUT

1/8" Stereo Headphone Output.

AUDIO OUT

1/4" Unbalanced Output.

AUDIO IN

External Audio Input for processing audio through the Mixer and Filter section of the Minitaur.

CONTROL INPUTS

Analog control inputs for Pitch, Filter, Volume and Gate. Use control voltage or a Moog EP2 expression pedal to connect and control the Minitaur with everything from Moogerfoogers to modular systems.

MIDI

DIN MIDI and USB MIDI offer complete control of the Minitaur's sound engine.

SIGNAL FLOW

To understand how the Minitaur generates sound, take a look at the diagram below. It shows the flow of Audio, Control Voltage and Modulation signals in the Minitaur. Heavy lines indicate audio signals, which flow from left to right. Lighter lines indicate Control Voltages (CV's), which flow from the top and from the bottom. Dotted lines indicate Modulation routings.

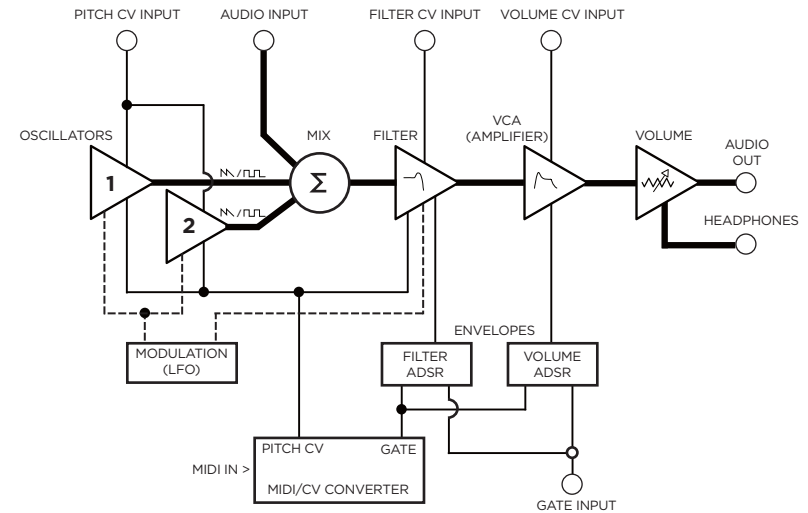

The Minitaur's source signals are created by two Voltage-Controlled Oscillators (VCO) which are mixed with the External Audio Input. The Mixer Output is routed to the Filter, where the tone is sculpted according to the Filter parameters and the Filter ADSR Envelope. The signal is then passed to the Amplifier (VCA) stage, where the Volume ADSR envelope shapes it. Finally, the signal is routed to the Output section, where the final level is set by the Volume control knob.

For most users, MIDI will be the main source of control for the Minitaur. Each time the Minitaur receives a MIDI "Note On" command, it produces a Pitch CV and Gate signal in response. The Pitch CV signal sets the Pitch of the Oscillators, while the Gate signal triggers the Filter and Volume ADSR Envelopes.

The Minitaur can also be operated via CV and Gate trigger connections, for a more 'old school' method of control. Both control methods (MIDI & CV/Gate) can be used at the same time, although some combinations of control signals may cause unpredictable results.

NOTE: DIN MIDI IN is not passed to USB MIDI OUT

BASIC OPERATION

The Minitaur responds to MIDI messages on both DIN and USB MIDI Inputs. In addition, Minitaur's knobs and switches transmit MIDI Control Change (CC) commands via MIDI USB, allowing parameter adjustments to be captured by any MIDI-recording device. Minitaur has an LED MIDI indicator that indicates MIDI activity on either the DIN MIDI or USB MIDI connector. To further extend the Minitaur's capabilities, there are additional parameters that can be accessed via MIDI control. A complete list of all MIDI CC commands can be found on page 22-23.

THE COMPONENTS

OSCILLATORS

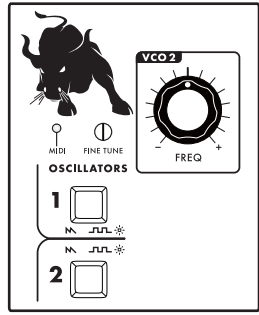

The Oscillators are the main sound source of Minitaur. They create electronic vibrations that can be tuned and amplified into sound that we can hear. The Minitaur's VCOs can produce a total musical range of 6 octaves.

OSCILLATOR 1 (VCO 1) serves as a master Oscillator to which OSCILLATOR 2 (VCO 2) is tuned. Two independent switches select the waveform for each Oscillator (Sawtooth or Square). A FINE TUNE control adjusts the master tuning of both Oscillators.

The frequencies of both Oscillators are affected by a number of sources. The main source is a 'Note On' command transmitted from an external MIDI controller or DAW. The 'Note On' command is translated into a Control Voltage that allows the Oscillators to be played in an equal-tempered scale. Other control sources include Minitaur's GLIDE circuit, VCO 2 FREQ, the PITCH CV INPUT, the FINE TUNE control, and the output of the MODULATION (LFO) circuit. The highest pitch produced by Minitaur's Oscillators is C5 (523.25 Hz) or MIDI note value 72.

PANEL CONTROLS FOR THE OSCILLATOR

OSCILLATOR 1 Switch (CC# 70):

Selects a Sawtooth (LED OFF) or Square wave (LED ON) for VCO 1.

OSCILLATOR 2 Switch (CC# 71):

Selects a Sawtooth (LED OFF) or Square wave (LED ON) for VCO 2.

VCO 2 FREQ (CC# 17):

Sets the frequency offset of VCO 2 from VCO 1. The offset range is +/-1 octave. Center position tunes VCO 2 in unison with VCO 1. *NOTE: If playing between notes 60 and 72, the pitch of VCO 2 is limited to note 72 (C4) regardless of this control setting.*

FINE TUNE:

Adjusts the frequency of both VCOs by approximately +/-1 semitone. The FINE TUNE control does not transmit MIDI.

MIDI ACCESSIBLE CONTROL

VCO 2 BEAT (CC# 18):

Selects the fine frequency offset for VCO 2. The adjustment range is +/- 50 cents.

Default = 64.

NOTE SYNC (CC# 81):

When enabled, NOTE SYNC forces both oscillators to start at the same time, eliminating any phase differences at the start of each "Note On" command. This ensures energy is consistent at the start of each new note. Default = OFF.

EXTERNAL CONTROL

The PITCH CV jack on the back panel is a CV input for external control of the Oscillator pitch. This input controls the frequencies of both Oscillators. A 1 volt change of this voltage will change the pitch by one octave. The jack accepts 0 to +5 volts, or an expression pedal like the Moog EP-2.

PERFORMANCE TIPS:

- For punchy bass lines, try using NOTE SYNC to keep the energy at the beginning of each note the same.
- A steady control voltage applied to the PITCH jack will offset the base pitch of both oscillators. You can use this feature to transpose the oscillators to any desired interval.
- To recreate the classic Taurus sound, choose the Sawtooth wave for one or both oscillators.

GLIDE

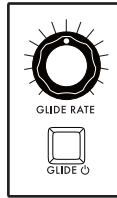

GLIDE (AKA 'portamento') is a musical effect that makes smooth changes in pitch between notes. The Minitaur's GLIDE RATE is adjustable from instantaneous to extremely long.

PANEL CONTROLS FOR GLIDE

GLIDE Switch (CC# 65):

Enables/Disables the GLIDE function. GLIDE is on when the LED is on.

GLIDE RATE (CC# 5):

Sets the rate of GLIDE that occurs when the note controlling the Minitaur changes.

MIDI ACCESSIBLE CONTROL

GLIDE TYPE (CC# 92):

The Minitaur offers three GLIDE types: Linear Constant Rate (LCR), Linear Constant Time (LCT), or Exponential (EXP). When LCR is selected, the GLIDE RATE stays the same regardless of the interval. When LCT is selected, the GLIDE TIME stays the same regardless of the interval. When EXP is selected, the GLIDE RATE follows an exponential curve that starts fast and then slows as it approaches the target note (like the Taurus).

Default = LCR.

LEGATO GLIDE (CC# 83):

Normally, GLIDE occurs with every new note. When LEGATO GLIDE is enabled, however, GLIDE is only applied when a new note is received while another note is still being held.

Default = OFF.

MIX (OSCILLATOR LEVELS)

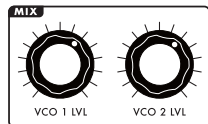

Each Oscillator (VCO 1 & VCO 2) has a dedicated level knob that allows you to control the relative strength of each oscillator from 0 to 100%. *NOTE: The VCOs begin to clip the filter at about 2 o'clock creating more aggressive sounds.*

PANEL CONTROLS FOR THE MIXER

VCO 1 LVL (CC# 15):

Sets the level of VCO 1.

VCO 2 LVL (CC# 16):

Sets the level of VCO 2.

MIDI ACCESSIBLE CONTROL

EXTERNAL INPUT LEVEL (CC# 27):

Adjusts the External Audio Input level. By default, the level is set for unity gain, but the level can be adjusted up to 200%
Default = 64.

FILTER

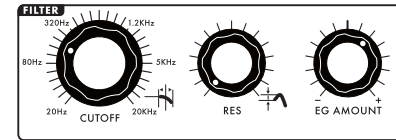

The FILTER is a classic Moog 24dB/Octave Low-Pass Filter design with resonance. It has controls for CUTOFF frequency which determines the range of frequencies the filter will affect, as

well as RESONANCE, which determines how much emphasis is applied to the harmonics near the Cutoff frequency (see figure).

The FILTER provides either fixed or dynamic timbre modifications. Dynamic changes are provided by the Filter Envelope Generator (EG), a Low Frequency Oscillator (LFO), or by an externally applied Control Voltage.

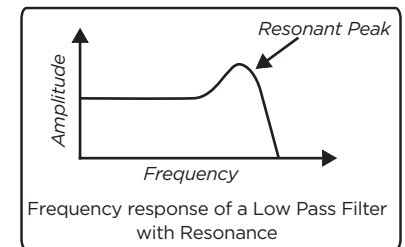

PANEL CONTROLS FOR THE FILTER

CUTOFF (CC# 19):

Adjusts the CUTOFF frequency of the Low Pass Filter from 20 Hz to 20 KHz. As the knob is rotated clockwise, the cutoff frequency is increased, allowing more harmonics to pass through the filter, resulting in a brighter sound. Conversely, as the knob is rotated counterclockwise, the sounds get darker. *NOTE: The Minitaur may not produce sound when this control is turned all the way down.*

RESONANCE (RES) (CC# 21):

Sets the amount of signal sent from the FILTER output to be fed back into it's input. This creates a peak in the frequency that can be increased all the

way to self-oscillation.

EG AMOUNT (CC# 22):

Determines how much the Filter Envelope Generator (EG) adds to or subtracts from the Filter Cutoff control setting. When the EG AMOUNT knob is set to positive (+), turn the FILTER CUTOFF knob left to hear the effect. When the EG AMOUNT knob is set to negative (-), turn the FILTER CUTOFF knob right to hear the effect. Note that if the Cutoff frequency is set very high, a positive EG Amount may have little or no noticeable effect, regardless of the setting. Similarly, if the Cutoff frequency is set low, a negative EG Amount may have little or no noticeable effect.

MIDI ACCESSIBLE CONTROL

FILTER KB TRACKING (CC# 20):

Determines how the Filter Cutoff changes in response to MIDI Note On values. Filter tracking is adjustable from 0 to 200%. Default = 32 (about 50%).

FILTER VELOCITY SENSITIVITY (CC# 89):

Sets the amount OF MIDI Note velocity to the Filter. Default = 64.

EXTERNAL CONTROL

The FILTER CV jack on the back panel is an input for external control of the Filter Cutoff parameter. A voltage applied to this jack is added to the setting of the Filter Cutoff control. A one-volt change in the Control Voltage will change the cutoff frequency of the filter by about one octave. The jack accepts 0 to +5 volts, or an expression pedal like the Moog EP-2.

ENVELOPES

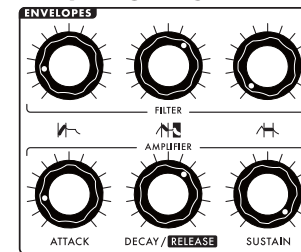

ENVELOPE GENERATORS (EGs) add motion to a sound after a note is played. The Minitaur has two separate Minimoog style Envelope Generators that affect the brightness and loudness of the Minitaur's sound by modulating the Filter Cutoff (VCF) and Volume (VCA).

The EGs are started by a Gate or MIDI Note message. Once started, their shape in time is set by the ATTACK, DECAY/RELEASE, and SUSTAIN controls, as well as the Release switch and length of the Note played.

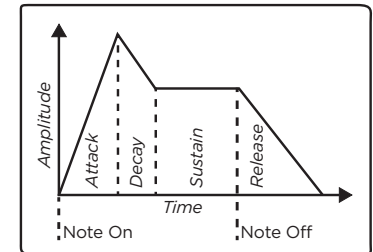

PANEL CONTROLS FOR THE ENVELOPES

FILTER ATTACK (CC# 23):

Sets the time it takes for the Attack portion of the Filter EG to rise from zero to maximum. The Attack time ranges from 1 msec to 30 seconds.

FILTER DECAY/RELEASE (CC# 24):

Sets the time for the Decay and Release portion of the Filter EG. When a note is held, and the Attack time end is reached, the Decay portion of the EG starts. During the Decay portion, the EG moves to the Sustain level. When a note is released, the EG moves back to zero at the rate set by this control. This time ranges from 1 msec to 30 seconds. The Release segment of the Envelope is determined by the state of the RELEASE switch (ON/OFF).

FILTER SUSTAIN (CC# 25):

Sets the Filter EG level after the Decay and before the Release portion. A note must be held longer than both the Attack and Decay time to reach the Sustain level. The level is adjustable from 0 to 100%.

AMPLIFIER ATTACK (CC# 28):

Sets the time it takes for the Attack portion of the Amplifier EG to rise from zero to maximum. The Attack time ranges from 1 msec to 30 seconds.

AMPLIFIER DECAY/RELEASE (CC# 29):

Sets the time for the Decay and Release portion of the Amplifier EG. When a note is held, and Attack time end is reached, the Decay portion of the EG starts. During the decay portion, the EG moves to the Sustain level. When a

note is released, the EG moves back to zero at the rate set by this control. The time ranges from 1 msec to 30 seconds. The Release segment of the Envelope is determined by the state of the RELEASE switch (ON/OFF).

AMPLIFIER SUSTAIN (CC# 30):

Sets the Amplifier EG level after the Decay and before the Release portion. A note must be held longer than both the Attack and Decay time to reach the Sustain level. The level is adjustable from 0 to 100%.

MIDI ACCESSIBLE CONTROL

OUTPUT (VCA) VELOCITY SENSITIVITY (CC# 90):

Sets the amount of MIDI Note velocity to the Amplifier. Default = 64 (50%).

EXTERNAL CV CONTROL

The GATE jack on the back panel is a trigger input that accepts a +5V Gate signal. Applying a Gate signal causes both Envelopes (Amplifier and Filter) to trigger simultaneously. *NOTE: When a Gate signal is applied, it overrides triggering via MIDI. You will still be able to control the Oscillator pitch and Modulation amounts from a MIDI controller, but the envelopes will not retrigger until the Gate trigger is removed.*

RELEASE



The RELEASE switch enables or disables the Release segment of both Envelope Generators. When enabled, the Envelope Release time is the same as the Envelope Decay time, and the DECAY control adjusts the time for both segments. When disabled, the Release segment does not occur and the Envelope stops abruptly in response to a "Note Off" message (or when the Gate CV goes to zero).

PANEL CONTROL FOR RELEASE

RELEASE Switch (CC# 72):

Enables/Disables the Release function for both Envelope Generators. RELEASE is enabled when the switch LED is ON.

MODULATION (MOD)

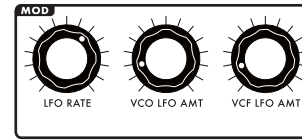

MODULATION is an important part in the creation of musically-expressive sounds. The Minitaur's MODULATION section provides an LFO with adjustable RATE and AMOUNT controls for the oscillators (VCO) and the Filter (VCF). The Low Frequency

Oscillator (LFO) is a signal used to move the pitch of VCOs and the Filter Cutoff up and down automatically. A LFO can be used to simulate vibrato, create wobbling filter sweeps, or make interesting synthesizer sounds.

PANEL CONTROLS FOR MODULATION

LFO RATE (CC# 3):

Sets the frequency of LFO Modulation. The range is from 0.01Hz to 100Hz.

VCO LFO AMOUNT (CC# 13):

Sets the maximum amount the LFO moves the VCOs pitch up and down, up to +/- 1 octave. Modulation affects both Oscillators. Amounts above MIDI Note 72 are clipped. If using a MIDI controller, the Mod Wheel (CC# 1) is used to fade the LFO Pitch Modulation in and out.

VCF LFO AMOUNT (CC# 12):

Sets the maximum amount the LFO moves the Filter Cutoff up and down, up to +/- 5 octaves. Amounts above 20KHz or below 20 Hz are clipped. If using a MIDI controller, the Mod Wheel (CC# 1) is used to fade the LFO Filter Modulation in and out.

MIDI ACCESSIBLE CONTROL

LFO MIDI SYNC ON/OFF (CC# 87):

Enables or Disables the ability of the Minitaur's LFO to sync to MIDI Clock messages. Default = ON.

LFO SYNC CLOCK DIVISION (CC# 86):

Selects the LFO Clock division when the LFO Sync Source is set to MIDI Clock. LFO Division Settings are listed on page 24. The LFO RATE control can also act as a Clock Divider. Default = 1/4.

LFO KEY TRIGGER (CC# 82):

Re-triggers the start of the LFO cycle when a NOTE ON message or KB GATE Control Voltage is received. Default = OFF.

***NOTE:** When the Minitaur powers up, the settings on the VCO LFO AMOUNT and VCF LFO AMOUNT controls have a direct effect on the VCO and VCF. This behavior continues until the Minitaur receives a MIDI Mod Wheel command, from which point the Mod Wheel takes master control of the LFO modulation amount set by the Amount controls.*

VOLUME (VCA)



The Minitaur features a monophonic Audio Output and a Headphone Output; both outputs appear on the back panel. Both outputs are adjusted simultaneously by the VOLUME control.

PANEL CONTROL FOR VOLUME

VOLUME:

Adjusts the output of the Voltage Controlled Amplifier (VCA) and Headphone levels. Rotating the control fully clockwise produces the maximum output. Rotating the control fully counterclockwise silences the Minitaur. The VOLUME control does not transmit or receive MIDI. This is a post VCA control.

MIDI ACCESSIBLE CONTROL

OUTPUT LEVEL (CC# 7):

Adjusts the Audio Output and Headphone volume levels.

VOLUME VELOCITY SENSITIVITY (CC# 90):

Velocity scales the amplitude of the Amplifier envelope Similar to traditional touch sensitivity.

Default = 64 (50%).

EXTERNAL CONTROL

The VOL CV jack on the back panel is an input for external control of the Output level. A voltage of 0 Volts silences the Minitaur and a voltage of 5 Volts corresponds to the output level set by the VOLUME control knob. The jack accepts a positive Control Voltage from 0 to 5 Volts, or an expression pedal like the Moog EP-2.

INPUT/OUTPUT PANEL

The back panel provides all of the input and output connections. In addition to AUDIO INPUT/OUTPUT jacks, there are CV and GATE inputs, connections for MIDI, and the Power Connector. The Minitaur does not have a power switch.

BACK PANEL

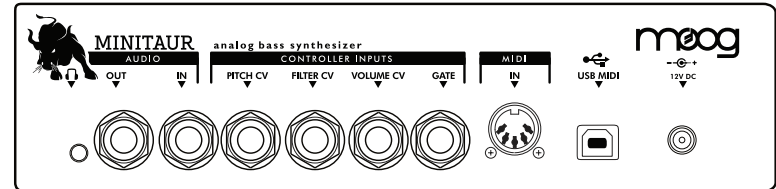

12VDC (POWER INPUT)

A barrel connector that accepts a +12VDC, tip positive power input from the power adaptor, which accepts 100-240 VAC, 50-60Hz.

CONTROLLER INPUTS

The PITCH, FILTER and VOLUME CV jacks supply power and will accept an expression pedal such as the Moog EP-2, or a Control Voltage from 0 to +5 Volts. The GATE input accepts a +5 Volt trigger signal.

MIDI (DIN AND USB)

Connections for DIN MIDI input and USB MIDI IN-OUT.

AUDIO IN

The AUDIO IN jack allows an external audio source to be mixed with the Minitaur's VCOs, and then routed to the Filter for processing. Although the Minitaur has no provisions for adjusting the level of this input on the front panel, the level is adjustable up to 200% via MIDI CC# 27.

AUDIO OUT

The AUDIO OUT jack provides an unbalanced line-level signal for connecting to an amplifier or mixer.

HEADPHONE OUTPUT

1/8" minijack for stereo Headphone Output. 32Ω or higher recommended impedance.

PERFORMANCE TIPS:

• You can use the Minitaur to process any audio signal simply by plugging into the AUDIO IN jack. To hear the external audio signal, you will need a MIDI NOTE ON message. To hear the external audio signal without issuing a MIDI NOTE ON message, apply +5V to the GATE jack. This will leave the Gate open, and the Amplifier Envelope will remain at its Sustain level until the Gate closes.

• The Minitaur's audio input is not limited to processing monophonic signals - it can work well for processing polyphonic signals, too. For example, connect the Audio Output of a MIDI-equipped polyphonic keyboard to the Minitaur's AUDIO IN jack, and turn the MIX level of VCO 1 and VCO 2 all the way down on the Minitaur. Now you have a polyphonic source affected by the Minitaur's Filter and Envelope circuits - a great way to warm up a sterile digital signal!

MIDI OPERATIONS

MIDI CHANNEL

The Minitaur sends and receives on a single MIDI channel. By default, the Minitaur is set to MIDI Channel 1, but it can be set to any MIDI Channel (1-16). To change the MIDI Channel on the Minitaur:

1. Connect your MIDI controller or DAW to the Minitaur.
2. Adjust the controller (or DAW) to transmit the desired MIDI Channel.
3. On the Minitaur; press and hold all four panel switches (VCO 1 Wave, VCO 2 Wave, GLIDE and RELEASE). The panel switch LEDs will blink, indicating that the Minitaur is waiting to set the new MIDI channel. The next MIDI message that the Minitaur receives (a Note On, CC, Pitch Bend etc...) will set the new channel.
4. Once in learn mode, press a key on the MIDI controller(or send MIDI data from the DAW). The Minitaur will reset its MIDI channel to match the channel being sent.

Changes to the Minitaur's MIDI channel are written to memory and are remembered on power down.

MIDI NOTE RANGE

The Minitaur responds to MIDI Note values 0-72; note values of 73 and higher are ignored.

PITCH BEND RESPONSE

By default, the PITCH BEND RESPONSE of the Minitaur is set to +/- 3 semitones. The Pitch Bend up and down values can be adjusted independently by issuing new values for MIDI CC#107 (Pitch Bend UP) and CC# 108 (Pitch Bend DOWN). See the MIDI CC Messages Table for the range of values.

MODULATION WHEEL (MOD WHEEL) RESPONSE

MIDI Mod Wheel messages control the maximum amount of modulation effect set by the VCO LMO AMT and VCF LFO AMT controls (MIDI CC# 1).

MIDI CONTROL CHANGE (CC) MESSAGES

The tables on the following pages list all MIDI CC messages for the Minitaur. Messages shown with an (M) indicate parameters which are only accessible via MIDI. Bolded values indicate the appropriate range for 7-bit messages (MSB).

NOTES:

- The Minitaur sends 7-bit MIDI CC messages for all parameters. It can receive either 7-bit or 14-bit values for the parameters controlled by knobs, but only 7-bit values for parameters controlled by switches.

- For all parameters, the MSB indicates the 'regular' CC number, and the LSB indicates the high-resolution 'fine' control value. If you are only sending 7-bit MIDI CC messages to the Minitaur, use the MSB number by itself. Note that when MSB-only messages are issued, the value range is always 0-127.

A NOTE ABOUT CONTROL PARAMETERS

LOCAL CONTROL OFF (CC# 122):

This parameter allows the front panel controls to send MIDI, but disconnects the Minitaur sound engine from direct control by the panel. Per the MIDI spec, only values of '0' and '127' work (0 = OFF, 127 = ON). If you are connected to a DAW using USB MIDI patched through, you may need this to avoid feedback artifacts. After changing the state of LOCAL CONTROL on/off, the Minitaur remembers the last setting after power down.

ALL SOUNDS OFF/ALL NOTES OFF (CC# 120 or 123):

Both of these parameters are MIDI 'panic' functions that are used to silence hung MIDI notes. Controllers or DAWs may send one or the other command which is why the Minitaur will respond to either.

SECTION	CONTROL/ PARAMETER	FUNCTION	CC	VALUE/RANGE
MOD(MODULATION)	LFO RATE	Adjusts the LFO frequency	3(MSB) 35(LSB)	0-127
	LFO VCO AMOUNT	Adjusts the modulation amount to the VCOs	13(MSB) 45(LSB)	0-127
	LFO VCF AMOUNT	Adjusts the Modulation amount to the VCF	12(MSB) 44(LSB)	0-127
	LFO MIDI SYNC (M)	Enables or disables ability of LFO to sync with MIDI CLOCK messages	87	0-63(INT) 64-127(MIDI CLOCK)
	LFO SYNC CLOCK DIV (M)	Sets the LFO synchronization clock divider	86	See table on page 24
	LFO KEY TRIGGER (M)	Re-triggers the LFO to the start of the cycle (Default is OFF)	82	0-63(OFF) 64-127(ON)
OSCILLATORS	VCO 1 WAVE	Selects the waveform of VCO 1	70	0-63(SAW) 64-127(SQR)
	VCO 2 WAVE	Selects the waveform of VCO 2	71	0-63(SAW) 64-127(SQR)
	VCO 2 FREQ	Adjusts the frequency of VCO 2	17(MSB) 49(LSB)	0-127 (64 is center)
	VCO 2 BEAT (M)	Adjusts the beat frequency of VCO 2 (Default is 64)	18(MSB) 50(LSB)	0-127
	NOTE SYNC (M)	Enables/disables Note Sync (Default is off)	81	0-63(OFF) 64-127(ON)
	GLIDE RATE	Adjusts the Glide (portamento) rate time	5(MSB)	0-127
	GLIDE SWITCH	Sets the state of the GLIDE switch (Glide is enabled when LED is lit)	65	0-63(OFF) 64-127(ON)
	GLIDE TYPE (M)	Selects the type of Glide; Linear Constant Rate, Linear Constant Time, or Exponential.	92	0-42(LCR) 43-84(LCT) 85-127(EXP)
	LEGATO GLIDE (M)	Sets the state of the Legato Glide parameter when GLIDE is enabled (Default is OFF)	83	0-63(Always Glide) 64-127(Glide on legato notes only)
MIXER	VCO 1	Adjusts the level of VCO 1	15(MSB) 47(LSB)	0-127
	VCO 2	Adjusts the level of VCO 2	16(MSB) 48(LSB)	0-127
	EXTERNAL IN LEVEL (M)	Adjusts the level of the External Audio Input (Default is 64 = 50% level)	27(MSB) 59(LSB)	0-127
FILTER	CUTOFF	Adjusts the Filter Cutoff frequency	19(MSB) 51(LSB)	0-127
	RESONANCE	Adjusts the Filter Resonance parameter	21(MSB) 53(LSB)	0-127
	EG AMOUNT	Adjusts the EG amount affecting the cutoff	22(MSB) 50(LSB)	0-127
	FILTER KB TRACK (M)	Sets the amount of keyboard tracking for the filter (Default is 32 - about 50%)	20(MSB) 54(LSB)	0-127
	FILTER VELOCITY SENSITIVITY (M)	Sets the amount of filter velocity sensitivity (Default is 64 - 50%)	89	0-127

SECTION	CONTROL/ PARAMETER	FUNCTION	CC	VALUE/RANGE
ENVELOPES	VCF ATTACK	Adjusts the filter envelope attack time.	23(MSB) 55(LSB)	0-127
	VCF DECAY/ RELEASE	Adjusts the filter envelope decay and release time	24(MSB) 56(LSB)	0-127
	VCF SUSTAIN	Adjusts the filter envelope sustain level	25(MSB) 57(LSB)	0-127
	VCA ATTACK	Adjusts the volume envelope attack time	28(MSB) 60(LSB)	0-127
	VCA DECAY/ RELEASE	Adjusts the volume envelope decay and release time	29(MSB) 61(LSB)	0-127
	VCA SUSTAIN	Adjusts the volume envelope sustain level	30(MSB) 62(LSB)	0-127
	RELEASE SWITCH	Sets the state of the Release parameter (enabled when LED is lit)	72	0-63(OFF) 64-127(ON)
	TRIGGER MODE (M)	Sets the state of the envelope trigger (Default is Legato ON)	73	0-42(LEGATO ON) 43-84(LEGATO OFF) 85-127(EG RESET)
VOLUME	VCA (OUTPUT) LEVEL (M)	Adjusts the audio output and headphone volume.	7(MSB) 39(LSB)	0-127
	VOLUME VELOCITY SENSITIVITY(M)	Sets the amount of volume velocity sensitivity (Default is 64 = 50%)	90	0-127
KEYBD RESPONSE	KEY PRIORITY(M)	Sets the Note Priority (Default is last)	91	0-42(LOW) 43-84(HIGH) 87-127(LAST)
MOD WHEEL RESPONSE	MOD WHEEL(M)	Modulation performance control	1(MSB) 33(LSB)	-
PITCH WHEEL RESPONSE	BEND UP AMOUNT (M)	Pitch Wheel 'UP' performance control (Default = +3 semitones)	107	0-15(OFF) 16-31(2 SEMITONES) 32-47(3 SEMITONES) 48-63(4 SEMITONES) 64-79(5 SEMITONES) 80-95(7 SEMITONES) 96-111(12 SEMITONES) 112-127(24 SEMITONES)
	BEND DOWN AMOUNT(M)	Pitch Wheel 'UP' performance control (Default = -3 semitones)	108	
CONTROL (SEE NOTE 1)	LOCAL CONTROL OFF(M)	Sets the state of the Local Control OFF parameter (Default is 127)	122	0 = OFF 127 = ON
	ALL SOUNDS OFF (M)	MIDI Panic message (Shuts off hung MIDI notes)	120	Any Value
	ALL NOTES OFF (M)	MIDI Panic message (Shuts off hung MIDI notes)	123	Any Value

MIDI CC VALUES FOR THE LFO CLOCK DIVIDER (CC# 86)

TIME VALUE	DIVISION	VALUE
1/64 Note Triplet	1/64 T	122-127
1/32 Note Triplet	1/32 T	116-121
1/32 Note	1/32	110-115
1/16 Note Triplet	1/16 T	104-109
1/16 Note	1/16	98-103
1/8 Note Triplet	1/8 T	92-97
Dotted 1/16 Note	1/16 DOT	86-91
1/8 Note	1/8	80-85
1/4 Note Triplet	1/4 T	74-79
Dotted 1/8 Note	1/8 DOT	68-73
1/4 Note	1/4	61-67
1/2 Note Triplet	1/2 T	55-60
Dotted 1/4 Note Triplet	1/4 DOT	49-54
1/2 Note	1/2	43-48
Whole Note Triplet	WH T	37-42
Dotted 1/2 Note	1/2 DOT	31-36
Whole Note	WH	25-30
Whole Note + Half Note	WH + 1/2	19-24
2 Whole Notes	2 Whole	13-18
3 Whole Notes	3 Whole	7-12
4 Whole Notes	4 Whole	0-6

APPENDIX A - MIDI IMPLEMENTATION CHART

FUNCTION	TRANSMITTED	RECOGNIZED	REMARKS
BASIC CHANNEL			
Default Changed	1 1-16	1 1-16	User Selectable
MODE			
Default Messages Altered	NO NO NO	4 NO NO	Note Priority MIDI CC# 91
NOTE NUMBER	NO	0-72	
VELOCITY			
Note On Note Off	NO NO	YES NO	
AFTER TOUCH	NO	NO	
PITCH BEND	NO	YES	Programmable from 0 ± 24 Semitones
CONTROL CHANGE	YES	YES	1,3,5,7,12,13,15-25, 27-30,33,35,37,39, 44,45,47-57,59-62, 65,70-73,81-83,86, 87,89-92,107,108, 120,122,123
PROGRAM CHANGE	NO	NO	
SYSTEM EXCLUSIVE	YES	YES	
SYSTEM COMMANDS			
Song Position Song Selection Tune	NO NO NO	NO NO NO	
SYSTEM REAL TIME			
Clock Commands	NO NO	YES YES	Receives Timing Clock
AUX MESSAGES			
Local Off All Notes Off Active Sense System Reset	NO NO NO NO	YES YES NO NO	

APPENDIX B - SERVICE AND SUPPORT INFORMATION

MOOG LIMITED WARRANTY

Moog Music warrants its products to be free of defects in materials and workmanship for a period of one year from the date of purchase. During the warranty period, any defective products will be repaired or replaced, at Moog Music's option, on a return-to-factory basis. This warranty covers defects that Moog Music determines are no fault of the user. In countries outside of the USA, contact a Moog authorized distributor listed on our web site (www.moogmusic.com) for service.

RETURNING YOUR PRODUCT TO MOOG MUSIC

You must obtain prior approval in the form of an RMA (Return Material Authorization) number from Moog Music before returning any product. To request an RMA number call us at **(828) 251-0090** or email techsupport@moogmusic.com. The Minitaur must be returned in its original packing. The warranty will not be honored if the product is not properly packed. Send the product to Moog Music Inc. with transportation and insurance charges paid.

MOOG MUSIC
160 Broadway St.
Asheville NC, 28801

WHAT WE WILL DO

Once received, we will examine the product for any obvious signs of user abuse or damage as a result of transport. If the product has been abused, damaged in transit, or is out of warranty, we will contact you with an estimate of the repair cost.

HOW TO INITIATE YOUR WARRANTY

Please initiate your warranty online at www.moogmusic.com/register. If you do not have web access please call **(828) 251-0090** to register your instrument. Registering your instrument initiates your warranty, ensures you receive the latest software updates, and gets you a nifty sticker!

APPENDIX C - CARING FOR THE MINITAUER

Clean the Minitaur with a soft, slightly moist cloth only – do not use solvents or abrasive detergents. Heed the safety warnings at the beginning of the manual. Don't drop the unit. If you are shipping your Minitaur to the factory for servicing, we recommend using the original shipping carton, or an ATA approved Road Case.



AN IMPORTANT NOTE ABOUT SAFETY: *Do not open the chassis. There are no user serviceable parts in the Minitaur. Maintenance of the Minitaur synthesizer should be referred to qualified service personnel only.*

APPENDIX D - USING THE CP-251 WITH THE MINITAUER

The Moog CP-251 Control Processor makes an ideal companion to the Minitaur. It provides an LFO with two waveforms (Triangle/Square), a Sample & Hold circuit with two outputs (Stepped/Smooth), a Lag Processor, Noise source, and a Mixer and two Attenuators. The CP-251 greatly expands the sonic palate of the Minitaur, allowing for the creation of new sonic textures.

Here are some possible configurations for using the CP-251 with the Minitaur. Grab some patch cords and try these suggestions!

NOISE AS AN AUDIO SOURCE

You can use the CP-251 Noise source as an audio source to add interesting artifacts to an existing sound (for example, creating the illusion of 'breath') or process the noise just by itself to create snare, wind, and surf sounds. Simply route the CP-251 Noise output through an attenuator and then into the Minitaur's Audio In jack. Noise never sounded so good!

NOISE AS A CONTROL VOLTAGE

You can use the CP-251 Noise source as a Control Voltage by simply routing it to any of the Minitaur's CV inputs (PITCH, FILTER and VOLUME), but a better method is to route the Noise through an Attenuator first:

1. Using a 1/4" patch cable, connect the CP-251 Noise output to an Attenuator input.
2. With another 1/4" patch cable, connect the Attenuator output to one of the Minitaur's CV jacks.

This will allow you to raise or lower the Noise level as desired, adding just a touch of noise to add realism to a sound, or a blast of noise for extreme sonic effect.

COMPLEX TIMBRAL MODULATION

1. Using a 1/4" patch cable, connect the CP-251 LFO Triangle output to an Attenuator Input
2. With another 1/4" patch cable, connect the Attenuator Output to the Minitaur's FILTER CV jack.
3. On the Minitaur, set the LFO RATE control and the VCF LFO AMOUNT controls to the 12 o'clock position.

On the CP-251, set the LFO Rate control to 1 o'clock and adjust the Attenuator to +3 on the dial. This will result in a complex modulation effect as the Filter Cutoff Frequency is modulated by both LFOs. Setting the LFO rates considerably higher will result in even wilder timbral textures, while very low settings will create slowly evolving complex filter sweeps. For a "random stepping" filter effect, use the S&H Out 1 in place of the LFO Triangle out.

Using the multiple jack on the CP-251, you can simultaneously route the LFO or S&H modulation signal to the Minitaur's Pitch, Filter and Volume inputs all at once, or split the modulation signal using the multiple jack and route it into both Attenuators to have two controllable modulation sources.

WE'VE JUST SCRATCHED THE SURFACE

Other CV-equipped gear like our Moogerfooger analog effects can be used to expand the sonic potential of the Minitaur. We encourage you to experiment; whether you are trying to create an original sound or duplicate an existing sound, experimentation is part of the fun!

APPENDIX E - SPECIFICATIONS

TYPE: Programmable Monophonic
Analog Bass Synthesizer

SYNTH ENGINE:

Oscillator Section:

- OSCILLATOR 1:
Wave: Sawtooth/Square
Level: 0 to 100%
- OSCILLATOR 2:
Frequency: ± 12 Semitones
Wave: Sawtooth/Square
Level: 0 to 100%
- GLIDE RATE: 0 to 100%

Filter Section:

- CUTOFF: 20Hz to 20KHz
- RESONANCE: 0 to Self-Oscillation
- FILTER ENV. AMOUNT: -100% TO +100%

Envelope Generator Section (x2):

- ATTACK TIME: 1 msec to 30 sec
- DECAY TIME: 1 msec to 30 sec
- SUSTAIN LEVEL: 0 to 100%
- RELEASE TIME: 1 msec to 30 sec
- RELEASE: On/Off

Modulation Section:

- LFO RATE WITH RATE LED: 0.01 to 100Hz
- WAVE: Triangle
- AMOUNT TO VCO: 0 to 100%
- AMOUNT TO VCF: 0 to 100%

PERFORMANCE CONTROLS:

- FINE TUNE: ± 1 Semitone
- GLIDE: On/Off
- RELEASE: On/Off
- MASTER VOLUME

APPENDIX E - SPECIFICATIONS

REAR PANEL:

- 12VDC POWER INLET:
Accepts +12VDC, tip positive
- MONOPHONIC AUDIO IN (1/4" TS-UNBALANCED)
Accepts +4dBu line level signal
- MONOPHONIC AUDIO OUT (1/4" TS-UNBALANCED)
- HEADPHONE JACK (1/8" TRS STEREO MINIJACK)
- CONTROL VOLTAGE INPUTS:
Pitch CV: 0 to +5V
Filter CV: 0 to +5V
Volume CV: 0 to +5V
Gate: +5V trigger
- DIN MIDI: MIDI Input
- USB MIDI: MIDI input, MIDI Output

DIMENSIONS:

- 8.75" x 5.12" x 3.12"
- (222.3mm x 130.2mm x 79.4mm)

WEIGHT:

- 2.5 lb
- (1.2 kg)

OPERATING SYSTEM:

- FLASH UPGRADEABLE VIA MIDI SYSEX

POWER CONSUMPTION:

- 7 WATTS

*Specifications subject to change without notice

©2012 MOOG MUSIC Inc. 160 Broadway St. Asheville, NC 28801
Phone: 828.251.0090 Email: info@moogmusic.com
Website: www.moogmusic.com

MINITOUR REV 2 ADDENDUM



PRESETS

Minitaur can now store up to 100 presets in internal memory. Presets can be saved and loaded using the Minitaur REV 2 Editor, or via any sysex utility.

TO SCROLL THROUGH PRESETS FROM THE FRONT PANEL:

While holding the **GLIDE** button, press the **VCO 1** button to increment presets or press the **VCO 2** button to decrement presets.

Hold the **GLIDE** button and press both **VCO 1** and **VCO 2** buttons to return to panel mode (Preset 0).

DECAY/RELEASE CONTROL

REV 2 introduces a new operational mode for the Envelope **DECAY/RELEASE** knobs.

DECAY AND RELEASE MODES

To toggle between Mode 1 and Mode 2 press and hold the **RELEASE** switch for 1 second. The **RELEASE** switch LED will blink one time to indicate Mode 1, or two times to indicate Mode 2. (The selected mode is remembered on power-down).

MODE 1 - Control of **DECAY** and **RELEASE** functionality is linked.

MODE 2 - Turning the **DECAY/RELEASE** knob by itself adjusts **DECAY** time. To adjust the **RELEASE** time, press and hold the **RELEASE** switch while turning the **DECAY/RELEASE** knob.

NOTE: *The Release On/Off function is now toggled when the panel button is released.*

CV MAPPING

In REV 2, the **PITCH**, **VOLUME**, and **GATE** Controller Inputs on Minitaur can be re-mapped to control other parameters. This allows you to use control voltage in new and creative ways.

The **PITCH** and **VOLUME** inputs provide continuous control, like the panel knobs, while the **GATE** input only provides on/off type control. Therefore, the **PITCH** and **VOLUME** inputs can be re-mapped to any parameter, while the **GATE** input can only be used to control two-state parameters (on or off).

CV Mapping is configured in the Minitaur Editor/Librarian software on the Hardware Settings panel (Ctrl/command+3 to display). There is a CV Mapping menu for **PITCH**, **VOLUME**, and **GATE**. Simply click any item on these menus to select a new destination.

NOTE: *CV Mapping settings are global; they do not change per preset and are saved on power down. To reset all Controller Inputs to default settings, simply click the Default Mappings button on the Minitaur Editor Hardware Settings panel.*

MINITAUR REV 2 ADDENDUM



CV TO MIDI CONVERSION

Minitaur can now convert multiple channels of Control Voltage to MIDI! This allows you to take CV sources such as modular synths, a CP-251 Control Processor or a Moog Etherwave Pro Theremin, and translate the voltage into MIDI control for your plug-in effects, soft synths, or other MIDI gear.

All Minitaur sound parameters have an assigned MIDI CC number. When a parameter value changes, Minitaur sends out MIDI CC data over its USB MIDI connection. When one of the Controller Inputs is mapped to a non-default parameter, Minitaur will send out CC messages for that parameter in response to control voltage changes at the input.

In order to get optimal response from the CV to MIDI conversion, you will need to adjust the scale and range of the control voltage to stay within the range of 0 to +5 Volts, before applying voltage to the Controller Input.



WARNING: Do not apply a negative control voltage, or a CV greater than +5 Volts.

MINITAUR'S GLOBAL PARAMETERS AND THEIR DEFAULT VALUES:

MIDI CLOCK LED ENABLE: OFF, ON / DEFAULT = OFF / 14 BIT

MIDI OUTPUT: OFF, ON / DEFAULT = OFF / *NOTE: If on, panel knobs send 14 bit CC data.*

DECAY/RELEASE MODE: MODE 1 (Decay/Release are linked) / MODE 2 (Decay/Release independent) / DEFAULT = MODE 1

KNOB MODE: SNAP, PASS-THRU, AND RELATIVE / DEFAULT = RELATIVE

MIDI CHANNEL IN: 1 - 16 / DEFAULT = 1

MIDI CHANNEL OUT: 1 - 16 / DEFAULT = 1

KEYBOARD PRIORITY: LOW, HIGH, LAST NOTE / DEFAULT = LAST NOTE

TRIGGER MODE: SINGLE TRIGGER (legato on), MULTI-TRIGGER (legato off) / DEFAULT = SINGLE TRIGGER

LFO SYNC PHASE RESET: OFF, ON / DEFAULT = ON

LOAD PRESET MOD WHEEL VALUE: OFF, ON / DEFAULT = OFF

MINITAUR REV 2 ADDENDUM



LFO SYNC PHASE RESET

LFO Sync Phase Reset in the Minitaur REV 2 Editor is labeled LFO Phase Reset. This parameter affects the LFO behavior while it is synced to MIDI. If LFO Sync Phase Reset is ON, then the LFO waveform is reset to the start of its cycle on the beginning of every “beat” according to the current MIDI clock settings. Since the LFO rate is set to give one cycle per “beat”, this Phase Reset is usually inaudible, as it lines up with where the start of the cycle should already be. This reset corrects for clock inaccuracies that could otherwise cause the LFO to drift relative to the beat.

NOTE: *If you sweep the LFO Rate knob while in MIDI sync, this can cause abrupt and noticeable jumps in the LFO if it is reset mid-cycle. If LFO Sync Phase Reset is OFF, then you can sweep the LFO Rate while in MIDI Sync, however you may find that the LFO cycle drifts relative to the beat.*

KNOB MODE

This parameter controls the behavior of Minitaur’s panel knobs when their physical position does not match the associated parameter value, which often happens when changing presets. In **SNAP MODE**, as soon as the knob is moved, the parameter value jumps to the current knob position. In **PASS-THRU MODE**, turning the knob will have no effect on the sound until the knob position matches (“passes through”) the parameter value, after which the knob behaves as normal. In **RELATIVE MODE**, turning the knob adjusts the parameter value proportionally, so that there are no sudden jumps in value.

LOAD PRESET MOD WHEEL VALUE

If On, loads a saved Mod Wheel value on preset load (the Mod Wheel value that was active when the preset was saved). If Off, then the “live” / current Mod Wheel value persists when changing presets.

meog

